

SUBARU



WARNING :













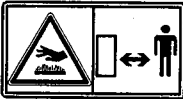
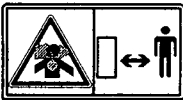



The engine exhaust from this product contains chemicals known to the State of California to cause cancer, birth defects or other reproductive harm.

CONTENTS

1. SAFETY PRECAUTIONS	1
2. COMPONENTS	4
3. PRE-OPERATION CHECKS	5
4. ELECTRIC STARTING MODELS	7
5. OPERATING YOUR ENGINE	9
6. EASY TROUBLESHOOTING	12
7. MAINTENANCE SCHEDULE	14
8. "HOW-TO" MAINTENANCE	15
9. PREPARATION FOR STORAGE	18
10. SPECIFICATIONS	19

FOREWORD

SYMBOLS

	<p><i>Read the owner's manual.</i></p>		
	<p><i>Stay clear of the hot surface.</i></p>		
	<p><i>Exhaust gas is poisonous. Do not operate in an unventilated room.</i></p>		
	<p><i>Stop the engine before refueling.</i></p>		
	<p><i>Fire, open light and smoking prohibited.</i></p>		
	<p><i>On (Run)</i></p>		<p><i>Plus; Positive polarity</i></p>
	<p><i>Off (Stop)</i></p>		<p><i>Battery</i></p>
	<p><i>Engine oil</i></p>		<p><i>Engine start (Electric start)</i></p>
	<p><i>Add oil</i></p>		<p><i>Stop</i></p>
	<p><i>Fast</i></p>		<p><i>Diesel fuel</i></p>
	<p><i>Slow</i></p>		

1. SAFETY PRECAUTIONS

Please make sure you review each precaution carefully.

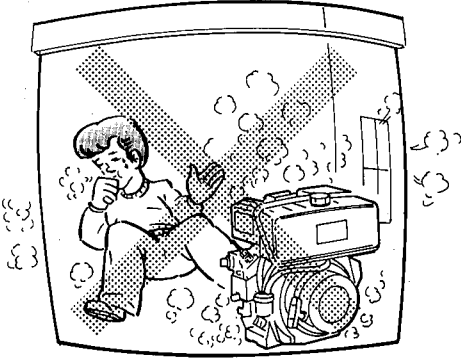

REFUELING- PRECAUTIONS

- Be sure to stop the engine prior to refueling.
- Do not overfill the fuel tank.
- If fuel is spilt, wipe it away carefully and wait until the fuel has dried before starting the engine.
- After refueling, make sure that the fuel cap is secured to prevent spillage.

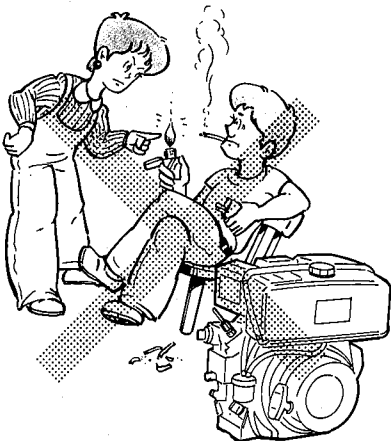

EXHAUST PRECAUTIONS

- Never inhale exhaust gasses. They contain carbon monoxide, a colorless, odorless and extremely dangerous gas which can cause unconsciousness or death.
- Never operate the engine indoors or in a poorly ventilated area, such as tunnel, cave, etc.
- Exercise extreme care when operating the engine near people or animals.
- Keep the exhaust pipe free of foreign objects.

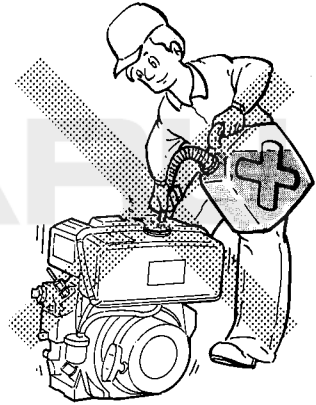

FIRE PREVENTION

- Do not operate while smoking or near an open flame.
- Do not use around dry brush, twigs, cloth rags, or other flammable materials.
- Keep the engine at least 3 feet (1 meter) away from buildings or other structures.
- Keep the engine away from flammables and other hazardous materials (trash, rags, lubricants, explosives).

1. SAFETY PRECAUTIONS

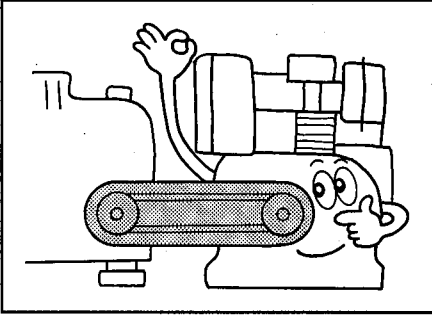

PROTECTIVE COVER

- Place the protective covers over the rotating parts.

If rotating parts such as the drive shaft, pulley, belt, etc. are left exposed, they are potentially hazardous.

To prevent injury, equip them with protective covers or shrouds.

- Be careful of hot parts.

The muffler and other engine parts become very hot while the engine is running or just after it has stopped.

Operate the engine in a safe area and keep children away from the running engine.

SUBARU

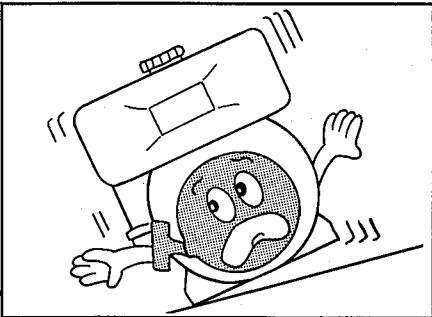

SURROUNDINGS

- Operate the engine on a stable, level surface free of small rocks, loose gravel, etc.

- Operate the engine on a level surface.

If the engine is tilted, fuel spillage may result.

NOTE :

Operating the engine at a steep incline may cause seizure due to improper lubrication even with a maximum oil level.

1. SAFETY PRECAUTIONS



- **Be careful of fuel spillage when transporting the engine.**

When the engine is transported over a long distance or on rough roads, drain fuel from fuel tank to prevent fuel leakage.

- **Do not move the engine while in operation when it has been removed from the equipment.**

- **Keep the unit dry (do not operate it in rainy conditions or near water).**

Subaru

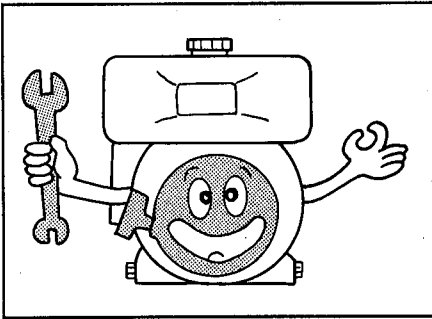

PRE-OPERATION CHECKS

- Carefully check fuel pipes and joints for looseness and fuel leakage.

Leaked fuel creates a potentially dangerous situation.

- Check bolts and nuts for looseness.

A loose bolt or nut may cause serious engine trouble.

- Check the engine oil and refill if necessary.

- Check the fuel level and refill if necessary.

Take care not to overfill the tank.

- Wear snug fitting working clothes when operating the engine.

Loose aprons, towels, belt, etc., may be caught in the engine or drive train, causing a dangerous situation.

2. COMPONENTS

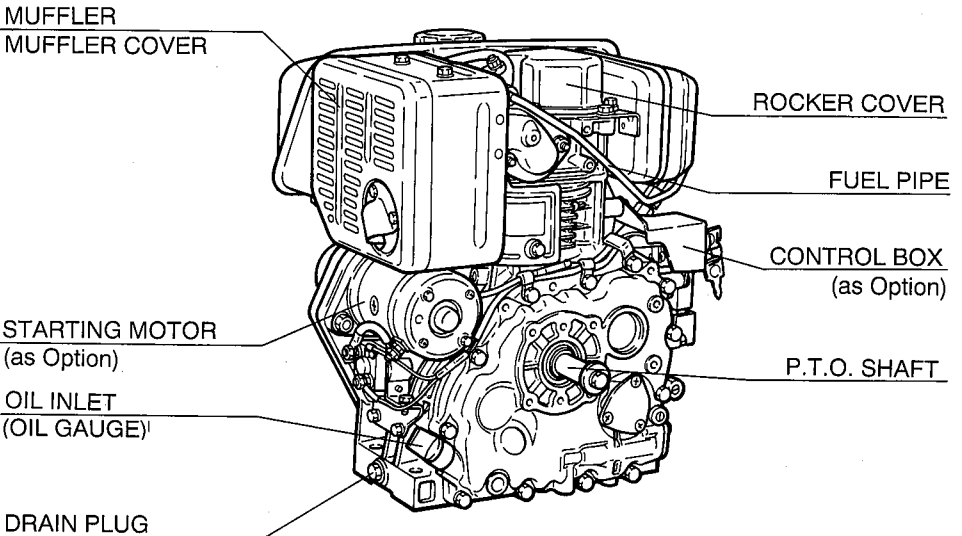
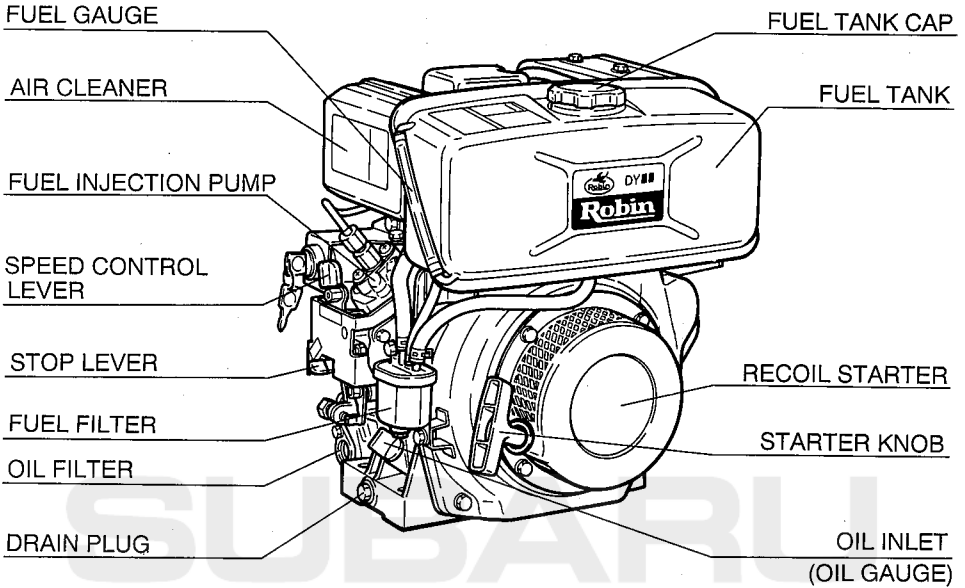

3. PRE-OPERATION CHECKS

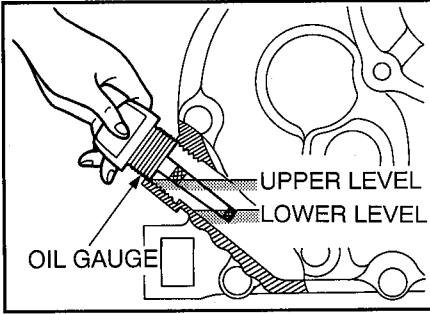

FILLING ENGINE OIL

Place the engine horizontally and pour oil up to the upper level of the oil gauge (approx. 0.9 liter).

- Use diesel engine oil with viscosity of :

SEASON or TEMPERATURE	GRADE OF OIL
Spring or Summer or Autumn 104°F (40°C) to +50°F (10°C)	SAE30
+68°F (20°C) to +14°F (-10°C)	SAE10W-30

Use diesel engine oil of grade “CC” or “CD” (API ranking). Inferior quality engine oil and/or lack of oil may cause an engine trouble or shorter engine life.

⚠ CAUTION

Do not use gasoline engine oil.
Use diesel engine oil only.
Do not screw the dip stick in when checking the oil.

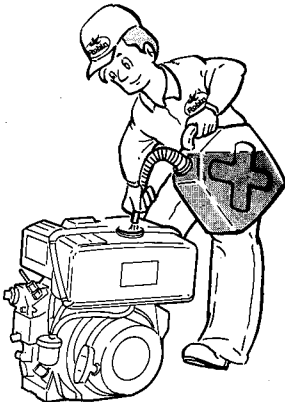

FILLING FUEL IN FUEL TANK

- Use automobile diesel fuel.
 - Fuel should be clean and fresh.
- Fuel around the bottom of drum contains dirt, impurities and water. If contaminated fuel is used, the fuel injection pump and nozzle may be clogged.
- Fuel tank capacity is 3.2 liters.
- If the fuel is spilt while refilling, wipe off thoroughly.
- Stop the engine first, then refill the fuel.

3. PRE-OPERATION CHECKS

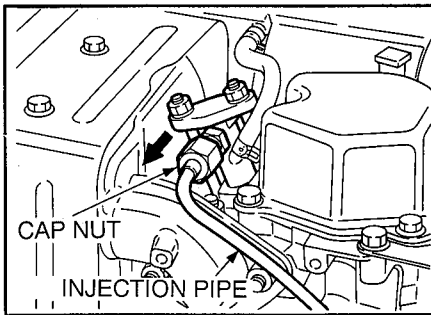
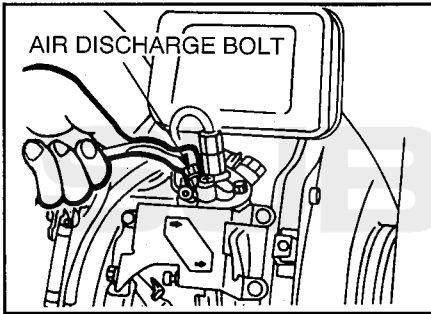
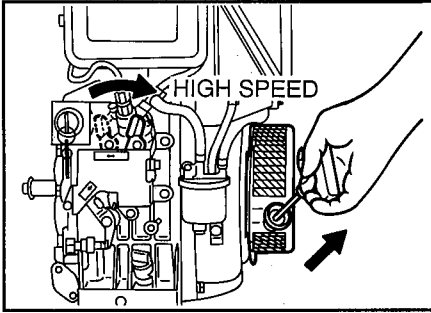

NOTE :

- If the fuel tank is refilled before it becomes empty, air discharging work is unnecessary.
- When discharging air from fuel system, be sure to fill fuel tank with enough fuel.

DISCHARGE AIR FROM FUEL SYSTEM

1. Engines with automatic air bleeding (Engines with std. fuel tank)

● When starting the brand new engine for the first time, or restarting the engine after it has stopped due to fuel shortage, discharge air from fuel system in the following procedure :

- (1) Set the speed control lever to the "HIGH" speed position.
- (2) Pull the recoil starter slowly two to three times. The air will be discharged automatically.

2. Engines without automatic air bleeding (Engines without fuel tank)

⚠ WARNING

Wipe off split fuel thoroughly before starting the engine, otherwise fire accident may occur.

● When restarting the engine in the following conditions, air discharge from fuel system is required.

- (a) Starting the brand new engine for the first time.
- (b) Restarting the engine after the engine has stopped due to fuel shortage.
- (c) Starting the engine after fuel filter cleaning.

● Air discharging procedure

- (1) Open the fuel cock.
- (2) With a 2.45 in. (10mm) spanner, loosen the air discharge bolt of the fuel injection pump and let fuel flow out until air bubbles disappear.
- (3) After finishing the above work, retighten the air discharge bolt.
- (4) Set the speed control lever to the "HIGH" speed position.
- (5) Loosen the cap nut and detach the injection pipe from the injection nozzle.
- (6) Pull the recoil starter slowly until sufficient fuel are injected from the injection pipe.
- (7) Attach the injection pipe to the injection nozzle tightening the cap nut securely.

4. ELECTRIC STARTER MODELS

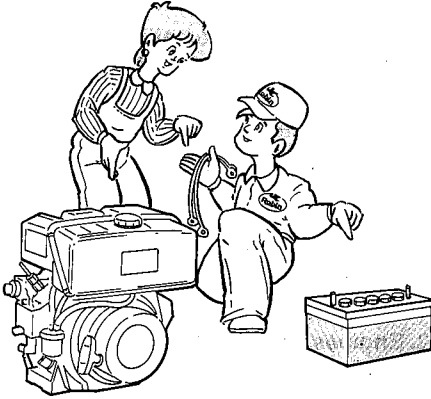

PREPARATION OF BATTERY

- (1) Use the battery with a capacity of 12V-24AH or larger.
- (2) Use the wire of proper gauge to connect battery, starter switch and starting motor.

A) BATTERY CABLE

CABLE LENGTH	CABLE DIA.	WIRE GAUGE		
		AWG(BS) BWG	SAE	JIS
Less than 1.5m	7.3mm	1	6	AV15
1.5m to 2.5m	8.5mm	0	4	AV20
2.5m to 4m	10.8mm	3/0	2	AV30

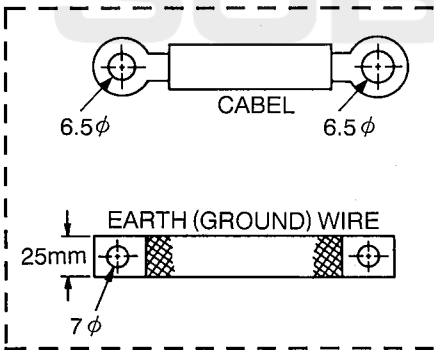

B) SWITCH CABLE

When remote key switch is used, select wires of proper gauge to connect key switch and magnetic switch on the engine.

CABLE LENGTH	CABLE DIA.	WIRE GAUGE		
		AWG(BS) BWG	SAE	JIS
Less than 1.5m	1.5mm	14	16	AV1.25
1.5m ~ 2.5m	1.9mm	12	14	AV2
3m ~ 5m	2.4mm	10	13	AV3

C) GROUND WIRE

Use a flat braided wire of 0.03 sq. in. (20mm²) or larger sectional area. (SAE GAUGE #4)

4. ELECTRIC STARTER MODELS

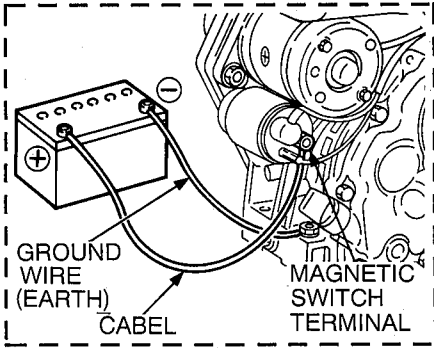

WIRING

1. Connect (+) terminal of the battery and magnetic switch terminal with a battery cable.
2. Connect (-) terminal of the battery to a grounded part of the engine or the equipment with a ground wire.

NOTE :

Tighten bolts and nuts on terminals securely so they will not be loosened by vibration.

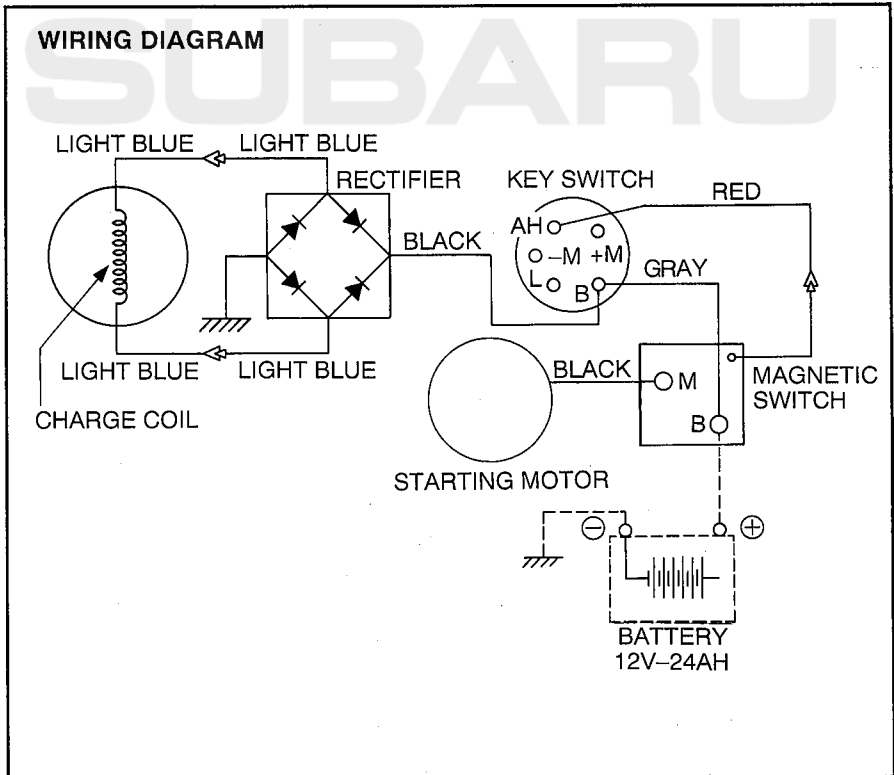

5. OPERATING YOUR ENGINE

STARTING

SPEED CONTROL LEVER

1

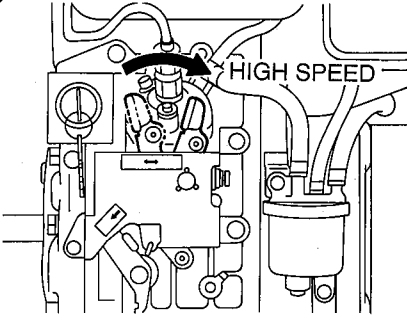

Set the speed control lever at the START position (HIGH SPEED).

RECOIL STARTER

(Starting by recoil starter)

2A

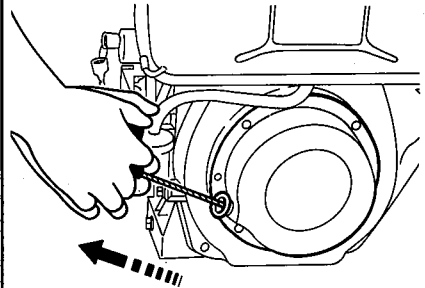

- Pull the recoil starter knob slowly and when you feel resistance, return its original position.
- Pull the starter knob swiftly with both hands.

CAUTIONS

- Be sure to pull the recoil starter knob forcibly.
- Do not pull out the rope all the way.

5. OPERATING YOUR ENGINE

KEY SWITCH (Electric Starter) (Starting by key switch)

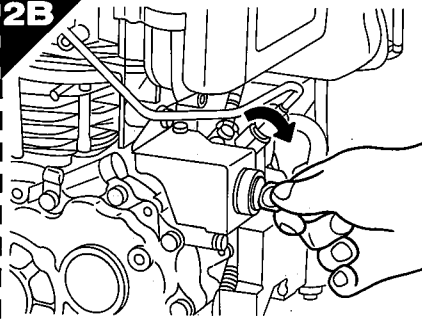

Insert the key into the key slot and turn it to the RUN position.

Turn it to the right (START position) to start the engine.

- Do not run the starter motor for more than 5 seconds.
- If the engine failed to start, set the key to RUN position and wait for 10 seconds and try starting again.
- Never turn the key switch to START position while engine is in running.
- If start the engine by recoil starter, set the key switch at the START position and pull the starter knob.
- After stopping the engine, be sure to set the key switch at the STOP position.

COLD STARTING

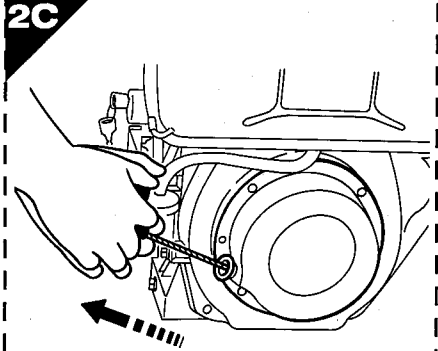

Inject the fuel by pulling the recoil starter knob slowly for several times. Then, pull the recoil starter knob forcibly to start the engine.

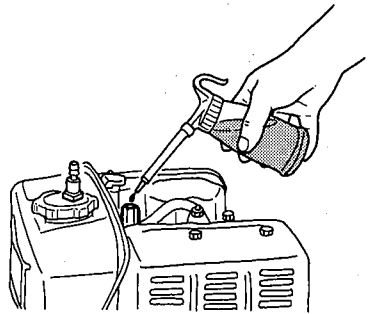

If the engine does not start yet, pour 2 to 3 cc of diesel fuel into an auxiliary fuel inlet locating on the rocker cover while pulling recoil starter knob slowly. Return the plug in to the inlet and start the engine.

5. OPERATING YOUR ENGINE

RUNNING

SPEED CONTROL LEVER

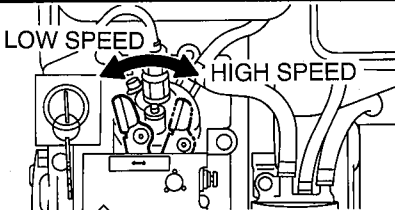

After the engine started, set the speed control lever at the low speed position (L) and warm it up without a load for a few minutes.

Gradually move the speed control lever toward the high speed position (H) and set it at the required engine speed.

NOTE :

Whenever high speed operation is not required, slow the engine down (idle) by moving the speed control lever to save the fuel and extend the engine life.

KEY SWITCH

(Electric Starter)

2

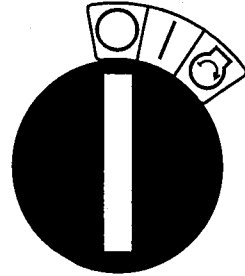

After the engine stopped, set the key switch at the STOP position and remove the key.

STOPPING

STOP LEVER

1

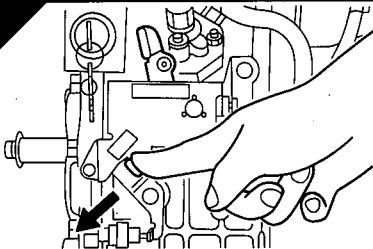

Set the speed control lever at the low speed position and allow the engine to run at low speed for 2 or 3 minutes before stopping, and push the stop lever down until the engine stops.

NOTE :

Note that the when the key is either at the STOP position or is being pulled out of the key switch while engine is running, the battery is not being charged.

6. EASY TROUBLESHOOTING



WHEN ENGINE DOES NOT START !

- Perform the following checks before you take the engine to your Robin dealer.
- If you still have trouble after completing the checks, take the engine to your nearest Robin dealer.

Is fuel tank filled up ?

1. Check the fuel gauge.
2. Check if the speed control lever is in "HIGH" position.
3. Disconnect the high pressure pipe on the side of the injection pump, and set the speed control lever to the "high speed" position.

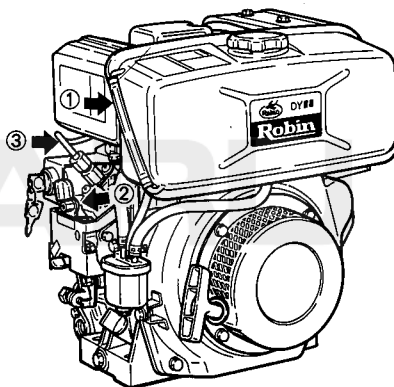

Is your battery well charged ?

1. If the battery for the electric starter is discharged, the engine does not start. Change the battery then try starting again.
2. Check wiring, especially connectors for tightness.

6. EASY TROUBLESHOOTING

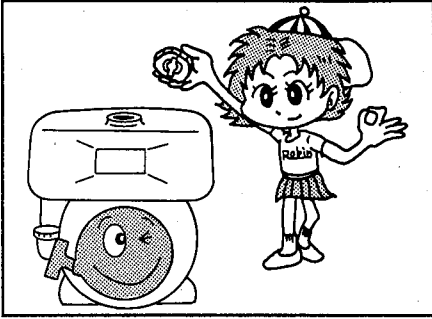

Are foreign objects contained in the fuel?

Drain all the fuel from the fuel tank and check that no foreign objects and/or water are contained in the fuel. (See page 16, titled "Bleeding water from the fuel filter.")

SUBARU

7. MAINTENANCE SCHEDULE

DAILY INSPECTION

Before running the engine, check the following service items.

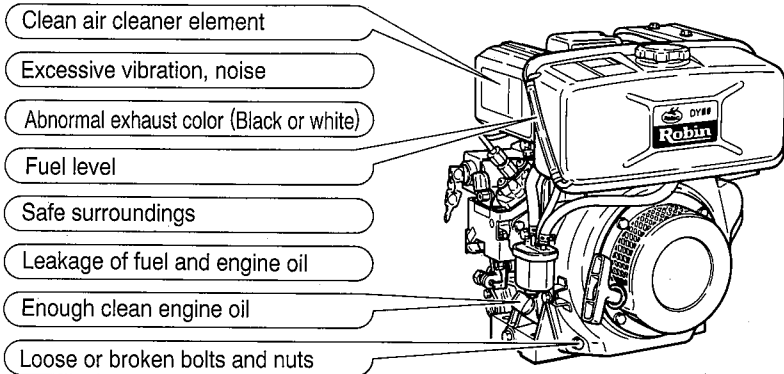

PERIODIC INSPECTION

Periodic maintenance is vital to the safe and efficient operation of your engine.

Check the table below for periodic maintenance intervals.

The following chart is based on the normal engine operation schedule.

- This mark indicates that special tools and skills are required. Consult your daler.

Items	Operating hours	8 hours (daily)	100 hours	500 hours	1000 hours
CHECK FOR OIL AND FUEL LEAKAGE.		○			
CHECK BOLTS AND NUTS FOR TIGHTNESS.		○			
CHACK ENGINE OIL		○ Refill everyday up to upper level.			
REPLACE ENGINE OIL.		○ Initially 25 hrs.	○		
CLEAN AIR CLEANER			○		
CHECK AND ADJUST VALVE CLEARANCE.				●	
DISCHARGE WATER FROM FUEL FILTER.				○ (300 hrs.)	○ Replace
REPLACE OR CLEAN OIL FILTR.			○		
CHECK NOZZLE AND CLEAN.				●	
CHECK VALVE SEAT.					●
CHECK BATTERY ELECTROLYTE LEVEL.			○ (monthly)		

8. "HOW-TO" MAINTENANCE

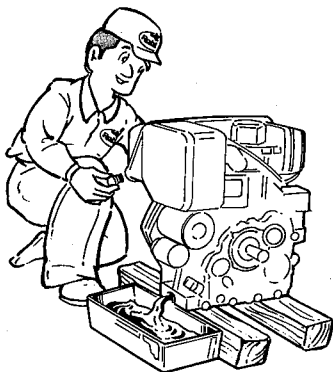

ENGINE OIL CHANGE AND OIL FILTER CLEANING

- Initial oil change
..... After 25 hours of operation
- Thereafter
..... Every 100 hours of operation

1. While the engine is still warm, remove the drain plug. For quick discharging, it is advisable to take off the oil gauge.
2. Before pouring the engine oil, tighten the oil drain plug firmly.
3. For the quality of the oil, refer to page 5.
4. Pour the engine oil up to upper level of the oil gauge.

- Use diesel engine oil of grade "CC" or "CD" (API ranking). If the engine oil is contaminated, not enough or poor quality oil is used, engine life will be shortened.
- When changing oil, clean the oil filter with diesel fuel.

SUB



CAUTION

Do not use gasoline engine oil.
Use diesel engine oil only.
Do not screw the dip stick in when checking the oil.

OIL CAPACITY 0.9 ℓ

8. "HOW-TO" MAINTENANCE

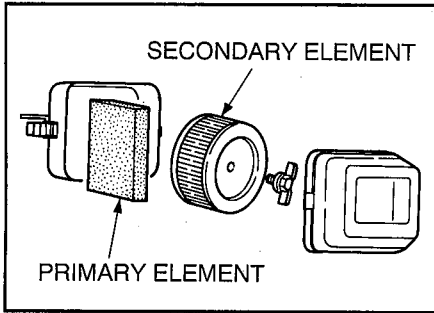

CLEANING AIR CLEANER

If the air cleaner is dirty, the engine will perform poorly due to air intake resistance. Always keep the air cleaner elements clean.

- After every 100 hours of operation, disassemble and clean the primary and secondary elements with detergent. After cleaning, dry them and attach.
- When operating the engine under extremely dusty conditions, clean the air cleaner elements every 30 ~ 50 hours of operation depending on the operating conditions.
- Use detergent and warm water to clean the air cleaner elements.
- Replace cleaner elements if it has been worn out after many times of cleaning.



CAUTION

Do not wash elements with kerosene, gasoline or oil.

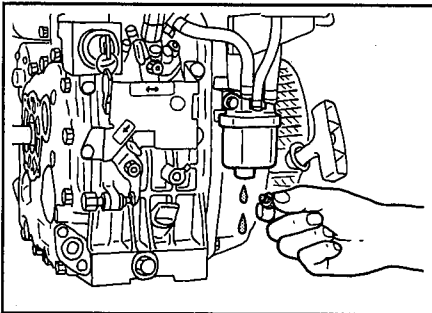

DISCHARGING WATER FROM FUEL FILTER

- After every 300 hours of operation, discharge water from the fuel filter, and every 1000 hours of operation, replace the filter assy. with new one.
- After cleaning, discharge the air from the fuel system. (See page 6.)

8. "HOW-TO" MAINTENANCE

CHECKING BOLTS, NUTS AND SCREWS

- Retighten loose bolts and nuts.
 - Check for fuel and oil leaks.
 - Replace damaged parts with new ones.
- Keep safety in your mind.

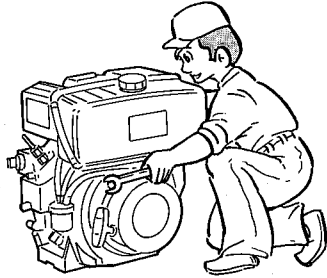

FUEL PIPE REPLACEMENT

Replace the fuel pipe every 2 years. If the leaking is found on a fuel pipe, replace it immediately.

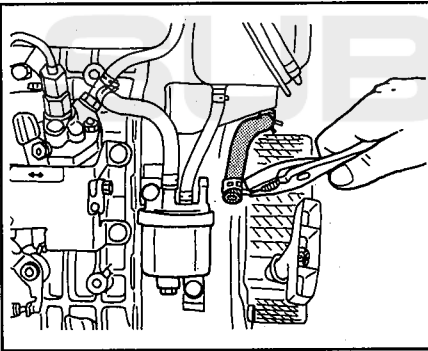

CHECK BATTERY

Refill the battery with distilled water, If the electrolyte fluid is below level line. Especially, amount of electrolyte consumed in summer is larger than that consumed in winter, which please keep in your mind.



9. PREPARATIONS FOR STORAGE

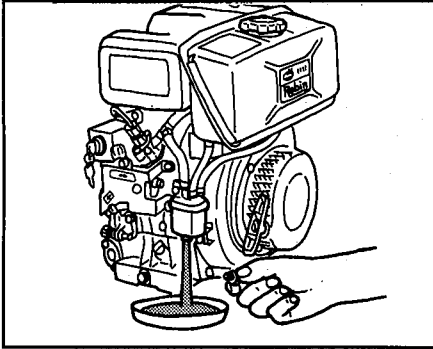

DISCHARGE FUEL (NO SMOKING !)

- Remove the drain screw of the fuel filter to discharge fuel.

ENGINE LUBRICATING OIL

- Change the used engine oil with fresh oil.
- Pour 4~5 engine oil into the auxiliary fuel inlet and pull the recoil starter knob slowly 2 or 3 times.
(Do not start the engine.)
- Be sure to put the plug into the inlet.

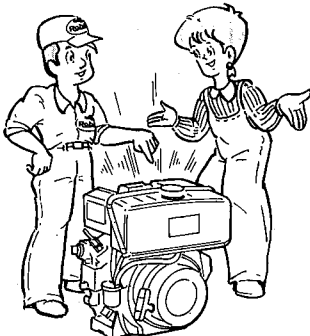
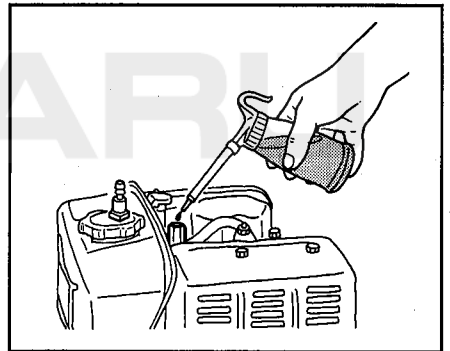

CLEAN AND STORE

- Pull the starter knob slowly until resistance is felt and leave it in that position.
- Disconnect the battery and charge it.
- Wipe the engine thoroughly with an oiled cloth, put the cover on, and store the engine indoors in a well-ventilated, low humidity area.

BATTERY CHARGING

- The battery discharges itself even when not connected, therefore it is necessary to recharge it once a month.

10. SPECIFICATIONS

MODEL	DY23-2D	DY23-2B	DY27-2D	DY27-2B
Type	Air-cooled, 4-Cycle, Vertical, Overhead Valve, Single Cylinder Diesel Engine			
Displacement	230 cm ³		265 cm ³	
Continuous Output	2.8KW/3000min ⁻¹ (3.8 HP/3000rpm)	2.8KW/1500min ⁻¹ (3.8 HP/1500rpm)	3.4KW/3000min ⁻¹ (4.5 HP/3000rpm)	3.4KW/1500min ⁻¹ (4.5 HP/1500rpm)
	3.1KW/3600min ⁻¹ (4.2 HP/3600rpm)	3.1KW/1800min ⁻¹ (4.2 HP/1800rpm)	3.7KW/3600min ⁻¹ (5 HP/3600rpm)	3.7KW/1800min ⁻¹ (5 HP/1800rpm)
Maximum Output	3.5KW/3600min ⁻¹ (4.8 HP/3600rpm)	3.5KW/1800min ⁻¹ (4.8 HP/1800rpm)	4.0KW/3600min ⁻¹ (5.5 HP/3600rpm)	4.0KW/1800min ⁻¹ (5.5 HP/1800rpm)
Direction of Rotation	Counterclockwise as viewed from P.T.O. shaft side			
Lubricant	Diesel Engine Lubricating Oil API classification "CC" or "CD" grade			
Fuel	Automotive Diesel Fuel			
Fuel Tank Capacity	3.2 liters			
Lighting Capacity (V-W/rpm)	12-39/3000 (as option) 12-43/3600 (as option)	12-39/1450 (as option) 12-43/1750 (as option)	12-39/3000 (as option) 12-43/3600 (as option)	12-39/1450 (as option) 12-43/1750 (as option)
Starting System	Recoil Starter (Electric Starter as Option)			
Dry Weight	29 kg (34 kg)	29.5 kg (34.5 kg)	29.5 kg (34.5 kg)	30 kg (35 kg)
Dimensions	Length	329 mm	339 mm	
	Width	357 mm	357 mm	
	Height	402 mm	402 mm	

Specifications are subject to change without notice.

ISSUE EMD-EU0956

SUBARU



SUBARU

FUJI HEAVY INDUSTRIES LTD.

INDUSTRIAL PRODUCTS COMPANY

4-410 ASAHI, KITAMOTO-SHI, SAITAMA, 364-8511, JAPAN

TEL:+81-48-593-7798, FAX:+81-48-593-7946

<http://www.fhi.co.jp/robin/>